

## YDS-KN6-OV5640-1B V4.1

### 5MP OmniVision OV5640-1B MIPI-Schnittstellen-Autofokus-Kameramodul



Vorderansicht



Rückansicht

#### Spezifikationen

<b>Kameramodul Nr.</b>	<b>YDS-KN6-OV5640-1B V4.1</b>
<b>Auflösung</b>	5MP
<b>Bildsensor</b>	OV5640-1B
<b>Sensorart</b>	1/4"
<b>Pixel Größe</b>	1.4 um x 1.4 um
<b>EFL</b>	3.29 mm
<b>F.NO</b>	2.80
<b>Pixel</b>	2592 x 1944
<b>Betrachtungswinkel</b>	68.7°(DFOV) 58.1°(HFOV) 45.0°(VFOV)
<b>Linsenabmessungen</b>	8.50 x 8.50 x 5.22 mm
<b>Modulgröße</b>	85.00 x 8.50 mm
<b>Modultyp</b>	Autofokus
<b>Schnittstelle</b>	MIPI
<b>Autofokus-VCM-Treiber-IC</b>	Eingebettet
<b>Objektivtyp</b>	650 nm IR-Schnitt
<b>Betriebstemperatur</b>	-30°C to +70°C
<b>Gegenstecker</b>	FH26W-25S-0.3SHW(60)



## YDS-KN6-OV5640-1B V4.1

### 5MP OmniVision OV5640-1B MIPI-Schnittstellen-Autofokus-Kameramodul



Ansicht von oben



Seitenansicht



Untersicht

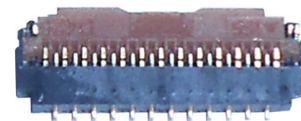

Gegenstecker



# Real Test Images

## KN6-OV5640-1B V4.1

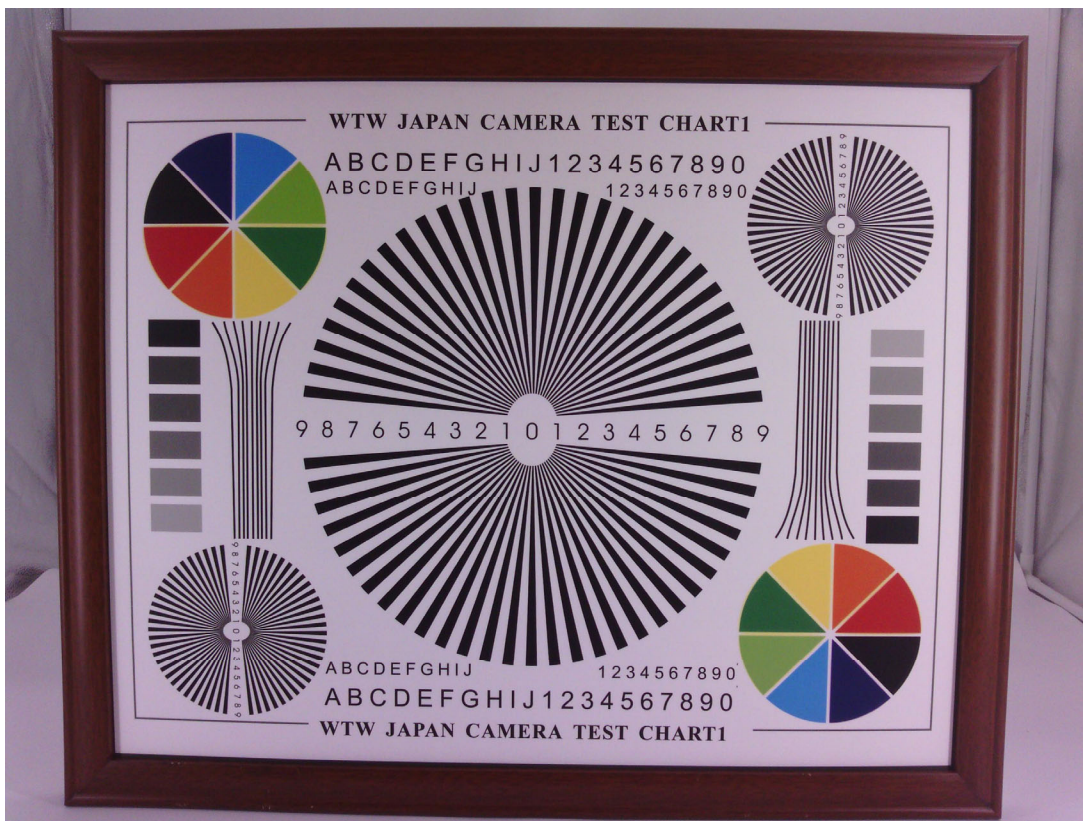

# Real Test Images

## KN6-OV5640-1B V4.1

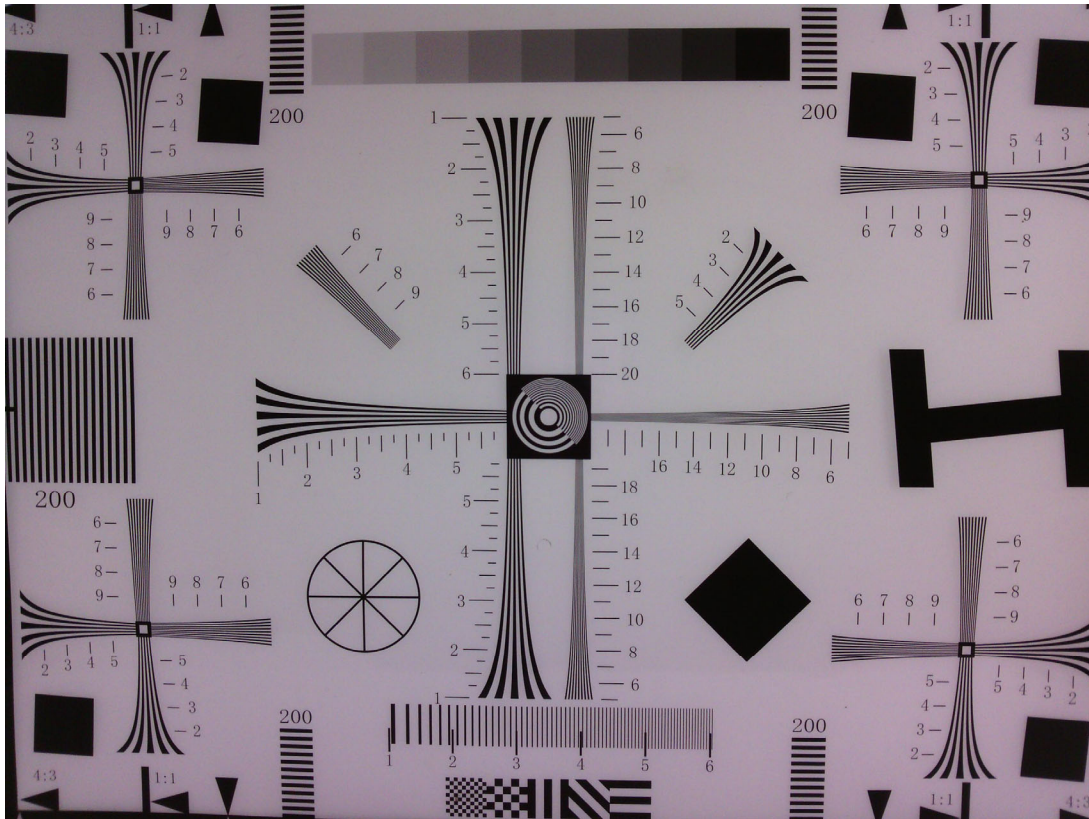



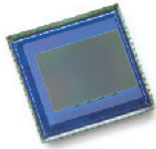

# OV5640 5-megapixel product brief



## 1/4-inch, 5-Megapixel SOC Image Sensor Optimized for High-Volume Mobile Markets



available in  
a lead-free  
package

The OV5640 delivers a complete 5-megapixel camera solution on a single chip, aimed at offering cost efficiencies that serve the high-volume autofocus (AF) camera phone market. The system-on-a-chip (SOC) sensor features OmniVision's 1.4 micron OmniBSI™ backside illumination architecture to deliver excellent pixel performance and best-in-class low-light sensitivity, while enabling ultra compact camera module designs of 8.5 mm x 8.5 mm with <6 mm z-height. The OV5640 provides the full functionality of a complete camera, including anti-shake technology, AF control, and MIPI while being easier to tune than two-chip solutions, making it an ideal choice in terms of cost, time-to-market and ease of platform integration.

The OV5640 enables 720p HD video at 60 frames per second (fps) and 1080p HD video at 30 fps with complete user control over formatting and output data transfer. The 720p/60 HD video is captured in full field of view (FOV) with 2 x 2 binning, which doubles the sensitivity and improves the signal-to-noise ratio (SNR). Additionally, a unique post-binning re-sampling filter function removes zigzag artifacts around slant edges and minimizes spatial artifacts to deliver even sharper, crisper

color images. To further improve camera performance and user experience, the OV5640 features an internal anti-shake engine for image stabilization, and it supports Scalado™ tagging for faster image preview and zoom.

The OV5640 offers a digital video port (DVP) parallel interface and a high-speed dual lane MIPI interface, supporting multiple output formats. An integrated JPEG compression engine simplifies data transfer for bandwidth-limited interfaces. The sensor's automatic image control functions include automatic exposure control (AEC), automatic white balance (AWB), automatic band filter (ABF), 50/60 Hz automatic luminance detection, and automatic black level calibration (ABLC). The OV5640 delivers programmable controls for frame rate, AEC/AGC 16-zone size/position/weight control, mirror and flip, cropping, windowing, and panning. It also offers color saturation, hue, gamma, sharpness (edge enhancement), lens correction, defective pixel canceling, and noise canceling to improve image quality.

Find out more at [www.ovt.com](http://www.ovt.com).

## applications

- cellular phones
- toys
- PC multimedia
- digital still cameras

## ordering information

- OV05640-A71A-1B** (color, lead-free)  
71-pin CSP

## features

- 1.4  $\mu\text{m}$  x 1.4  $\mu\text{m}$  pixel with OmniBSI technology for high performance (high sensitivity, low crosstalk, low noise, improved quantum efficiency)
- optical size of 1/4"
- automatic image control functions: automatic exposure control (AEC), automatic white balance (AWB), automatic band filter (ABF), automatic 50/60 Hz luminance detection, and automatic black level calibration (ABLC)
- programmable controls for frame rate, AEC/AGC 16-zone size/position/weight control, mirror and flip, cropping, windowing, and panning
- image quality controls: color saturation, hue, gamma, sharpness (edge enhancement), lens correction, defective pixel canceling, and noise canceling
- support for output formats: RAW RGB, RGB565/555/444, CCIR656, YUV422/420, YCbCr422, and compression
- support for video or snapshot operations
- support for internal and external frame synchronization for frame exposure mode
- support for LED and flash strobe mode
- support for horizontal and vertical sub-sampling, binning
- support for minimizing artifacts on binned image
- support for data compression output
- support for anti-shake
- standard serial SCCB interface
- digital video port (DVP) parallel output interface and dual lane MIPI output interface
- embedded 1.5V regulator for core power
- programmable I/O drive capability, I/O tri-state configurability
- support for black sun cancellation
- support for images sizes: 5 megapixel, and any arbitrary size scaling down from 5 megapixel
- support for auto focus control (AFC) with embedded AF VCM driver
- embedded microcontroller
- suitable for module size of 8.5 x 8.5 x <6mm with both CSP and RW packaging

## key specifications (typical)

- active array size:** 2592 x 1944
- power supply:**
  - core: 1.425 ~ 1.675V (with embedded 1.5V regulator)
  - analog: 2.6 ~ 3.0V (2.8V typical)
  - I/O: 1.8V / 2.8V
- power requirements:**
  - active: 140 mA
  - standby: 20  $\mu\text{A}$
- temperature range:**
  - operating: -30°C to 70°C junction temperature (see [table 8-2](#))
  - stable image: 0°C to 50°C junction temperature (see [table 8-2](#))
- output formats:** 8-/10-bit RGB RAW output
- lens size:** 1/4"
- lens chief ray angle:** 24° (see [figure 10-2](#))
- input clock frequency:** 6~27 MHz
- max S/N ratio:** 36 dB
- dynamic range:** 68 dB @ 8x gain
- maximum image transfer rate:**
  - QSXGA (2592x1944): 15 fps
  - 1080p: 30 fps
  - 1280x960: 45 fps
  - 720p: 60 fps
  - VGA (640x480): 90 fps
- sensitivity:** 600 mV/Lux-sec
- shutter:** rolling shutter / frame exposure
- maximum exposure interval:** 1964 x  $t_{\text{ROW}}$
- pixel size:** 1.4  $\mu\text{m}$  x 1.4  $\mu\text{m}$
- dark current:** 8 mV/s @ 60°C junction temperature
- image area:** 3673.6  $\mu\text{m}$  x 2738.4  $\mu\text{m}$
- package dimensions:** 5985  $\mu\text{m}$  x 5835  $\mu\text{m}$



# 0.3 mm Pitch, 1.0 mm Height FPC Connector

FH26 Series

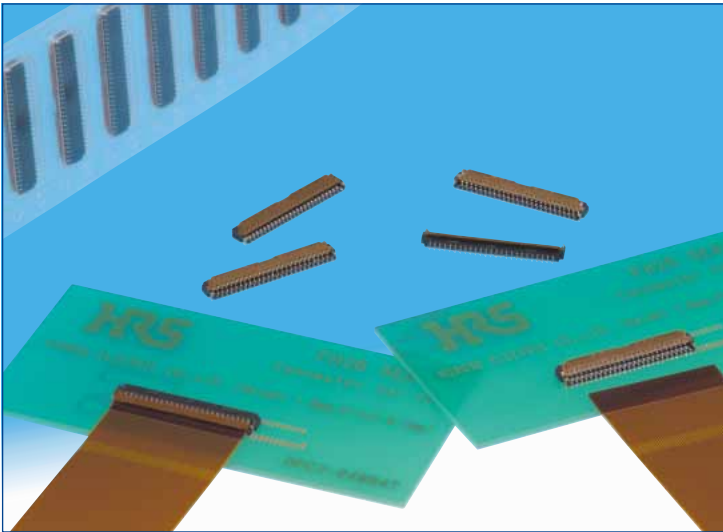

●Space saving(51 pos. shown)

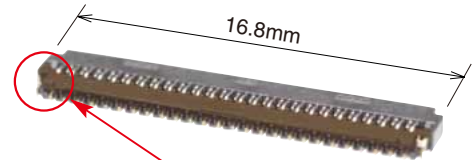
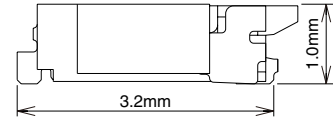

Metal fittings do not protrude outside of the connector body

## ■Features

### 1. Low-profile 0.3 mm pitch FPC connector

Ultra-thin design, 1.0 mm height, 3.2 mm width all add up to a compact, space saving form factor.

\*30% reduction in PCB footprint

\*40% reduction in weight

(Compared to our 0.3 mm pitch FH23 Series 51 position connector.)

### 2. Easy PCB Mounting

The leads are double sided and have a 0.6 mm mounting lead pitch to simplify mounting.

### 3. Fully molded structure aids PCB layout

The bottom of this connector is enclosed by a fully molded structure that protects the contacts and removes any restrictions from PCB patterning and design.

### 4. Rotating one-touch ZIF mechanism

The one-touch rotating ZIF mechanism is easier to operate and works with a light force, and a clear tactile click is delivered upon the successful completion of the mating process

### 5. Easy FPC insertion

The metal FPC insertion guides helps to make this the FPC insertion process easier.

### 6. FPC. Accepts standard 0.2 mm thick FPC

This connector accepts standard 0.2 mm thick FPC. (The proper FPC stiffener thickness will prevent FPC deformation and ease insertion and mating.)

### 7. Supports automatic pick-n-place mounting

Offered in tape and reel packaging that is compatible with automatic machine mounting. (5,000 pieces per reel)

### 8. Halogen-free

If you need a Halogen free connector, please use the FH26W type. All materials and substances used to produce the FH26W Series product complies with Halogen-free standards. \* Defined according to IEC61249-2-21

Br: 900ppm max, Cl: 900ppm max, Br+Cl: 1,500ppm max.

### 9. Multiple packing options

The standard packaging is 5,000 pieces per reel, but it is also offered in a 500 piece reel. (The outer diameter of the reel will be  $\phi$ 180 mm in this case.)

●Can be mounted over conductive traces.



No exposed contacts on the bottom of the connector

●Operation

- (1) Actuator open
- (2) Insert FPC

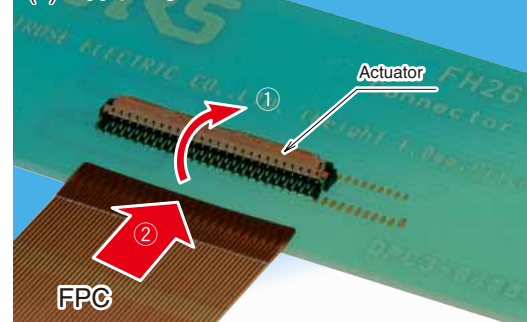

- (3) Close the actuator
- (4) FPC connected

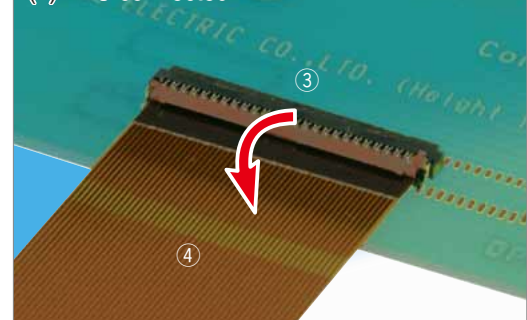

## ■ Specifications

Rating	Current rating	0.2A DC	Operating temperature range -55 °C to +85°C (Note 1) Operating humidity range Relative humidity 90% max. (No condensation)	Storage temperature range -10°C to +50°C (Note 2) Storage humidity range Relative humidity 90% max.
	Voltage rating	30V AC		

Recommended FPC :	Thickness: = 0.2±0.03mm gold plated
-------------------	-------------------------------------

Item	Specification	Conditions
1. Insulation resistance	50 M ohms min.	100 V DC
2. Withstanding voltage	No flashover or insulation breakdown.	90 V AC /one minute
3. Contact resistance	100 m ohms max. * Including FPC conductor resistance	1 mA
4. Durability (Insertion/ withdrawal)	Contact resistance: 100 m ohms max. No damage, cracks, or parts dislocation.	10 cycles
5. Vibration	No electrical discontinuity of 1μs or more. Contact resistance: 100 m ohms max. No damage, cracks, or parts dislocation.	Frequency: 10 to 55 Hz, single amplitude of 0.75 mm, 10 cycles, 3 directions.
6. Shock	No electrical discontinuity of 1μs. min. Contact resistance: 100 m ohms max. No damage, cracks, or parts dislocation.	Acceleration of 981 m/s <sup>2</sup> , 6 ms duration, sine half-wave waveform, 3 cycles in each of the 3 axis
7. Humidity (Steady state)	Contact resistance: 100 m ohms max. Insulation resistance: 50 M ohms min. No affect on appearance or performance.	96 hours at temperature of 40±2°C and humidity of 90% to 95%.
8. Temperature cycle	Contact resistance: 100 m ohms max. Insulation resistance: 50 M ohms min. No damage, cracks, or parts looseness.	Temperature: -55 °C→+15°C to +35°C→+85°C→+15°C to +35°C Time: 30 → 2 to 3 → 30 → 2 to 3 (Minutes) 5 cycles
9. Resistance to soldering heat	No deformation of components affecting performance.	Reflow: At the recommended temperature profile Manual soldering: 350°C +/-10°C for 5±1 seconds

Note 1: Includes temperature rise caused by current flow.

Note 2: The term "storage" refers to products stored for long period of time prior to mounting and use. Operating Temperature Range and Humidity range covers non- conducting condition of installed connectors in storage, shipment or during transportation.

## ■ Materials

Part	Material	Finish	Remarks
Insulator	LCP	Color: Black	UL94V-0
	PA	FH26 series: Deep brown FH26W series: Light brown	
Contacts	Phosphor bronze	Gold plating	_____
Metalfittings		Pure tin reflow plating	_____

## ■ Ordering information

FH
26
W
-
51S
-
0.3
SHW
(05)

① Series name: FH	⑥ Termination type SHW: SMT horizontal staggered mounting type ⑦ Specifications (10)...Gold plating with nickel barrier, 5,000 pieces / reel (99)...Gold plating with nickel barrier, 500 pieces / reel
② Series No.: 26	
③ Blank: Standard W: Satisfies halogen-free requirements (Flame retardance UL94HB).	
④ Number of positions: 13 to 71	
⑤ Contact pitch: 0.3mm	

## Connector Dimensions

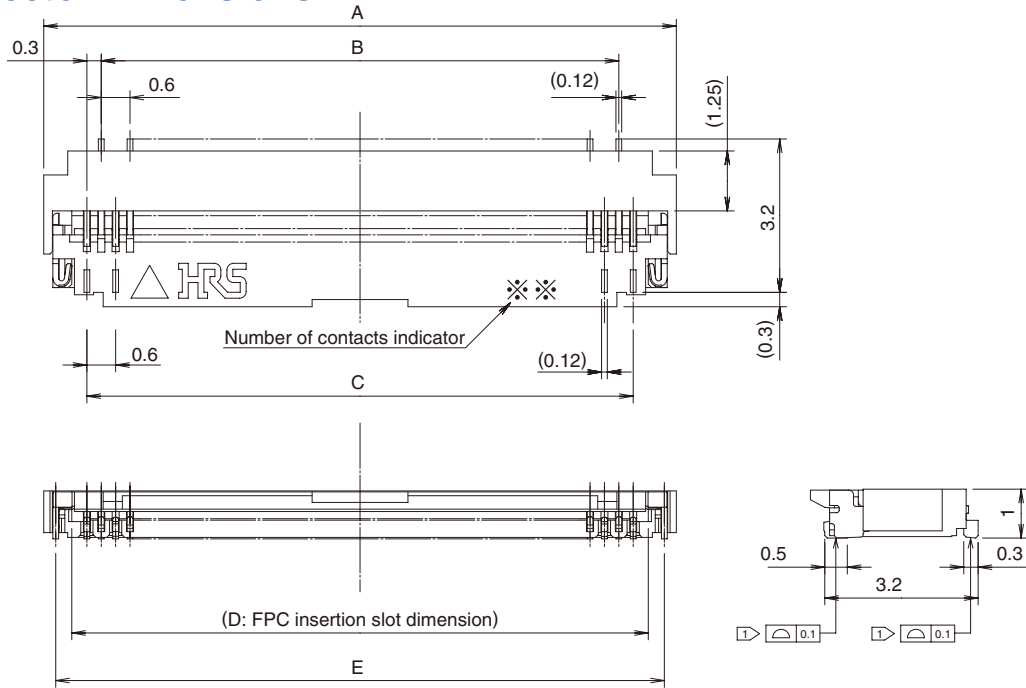

- Notes
- 1 The coplanarity of each terminal lead within specified dimension is 0.1 mm Max.
  - 2 Packaged on tape and reel only. Check packaging specification.
  - 3 Slight variations in color of the plastic compounds do not affect form, fit or function of the connector.
  - 4 After reflow, the terminal plating may change color, however this does not represent a quality issue.

All dimensions: mm

Part Number	CL No.	Number of Contacts	A	B	C	D	E
FH26-13S-0.3SHW(**)	580-0209-3-**-	13	5.4	3.0	3.6	4.23	4.9
FH26-15S-0.3SHW(**)	580-0218-4-**-	15	6.0	3.6	4.2	4.83	5.5
FH26-17S-0.3SHW(**)	580-0217-1-**-	17	6.6	4.2	4.8	5.43	6.1
FH26-21S-0.3SHW(**)	580-0207-8-**-	21	7.8	5.4	6.0	6.63	7.3
FH26-23S-0.3SHW(**)	580-0203-7-**-	23	8.4	6.0	6.6	7.23	7.9
FH26-25S-0.3SHW(**)	580-0208-0-**-	25	9.0	6.6	7.2	7.83	8.5
FH26-27S-0.3SHW(**)	580-0204-0-**-	27	9.6	7.2	7.8	8.43	9.1
FH26-29S-0.3SHW(**)	580-0216-9-**-	29	10.2	7.8	8.4	9.03	9.7
FH26-31S-0.3SHW(**)	580-0214-3-**-	31	10.8	8.4	9.0	9.63	10.3
FH26-33S-0.3SHW(**)	580-0210-2-**-	33	11.4	9.0	9.6	10.23	10.9
FH26-35S-0.3SHW(**)	580-0205-2-**-	35	12.0	9.6	10.2	10.83	11.5
FH26-37S-0.3SHW(**)	580-0224-7-**-	37	12.6	10.2	10.8	11.43	12.1
FH26-39S-0.3SHW(**)	580-0201-1-**-	39	13.2	10.8	11.4	12.03	12.7
FH26-41S-0.3SHW(**)	580-0206-5-**-	41	13.8	11.4	12.0	12.63	13.3
FH26-45S-0.3SHW(**)	580-0211-5-**-	45	15.0	12.6	13.2	13.83	14.5
FH26-51S-0.3SHW(**)	580-0200-9-**-	51	16.8	14.4	15.0	15.63	16.3
FH26-55S-0.3SHW(**)	580-0221-9-**-	55	18.0	15.6	16.2	16.83	17.5
FH26-57S-0.3SHW(**)	580-0212-8-**-	57	18.6	16.2	16.8	17.43	18.1
FH26-61S-0.3SHW(**)	580-0213-0-**-	61	19.8	17.4	18.0	18.63	19.3
FH26-71S-0.3SHW(**)	580-0202-4-**-	71	22.8	20.4	21.0	21.63	22.3

Part Number	CL No.	Number of Contacts	A	B	C	D	E
FH26W-13S-0.3SHW(**)	580-2401-1-**-	13	5.4	3	3.6	4.23	4.9
FH26W-15S-0.3SHW(**)	580-2402-4-**-	15	6.0	3.6	4.2	4.83	5.5
FH26W-17S-0.3SHW(**)	580-2403-7-**-	17	6.6	4.2	4.8	5.43	6.1
FH26W-19S-0.3SHW(**)	580-2437-9-**-	19	7.2	4.8	5.4	6.03	6.7
FH26W-21S-0.3SHW(**)	580-2404-0-**-	21	7.8	5.4	6.0	6.63	7.3
FH26W-23S-0.3SHW(**)	580-2405-2-**-	23	8.4	6.0	6.6	7.23	7.9
FH26W-25S-0.3SHW(**)	580-2406-5-**-	25	9.0	6.6	7.2	7.83	8.5
FH26W-27S-0.3SHW(**)	580-2400-9-**-	27	9.6	7.2	7.8	8.43	9.1
FH26W-29S-0.3SHW(**)	580-2407-8-**-	29	10.2	7.8	8.4	9.03	9.7
FH26W-31S-0.3SHW(**)	580-2408-0-**-	31	10.8	8.4	9.0	9.63	10.3
FH26W-33S-0.3SHW(**)	580-2409-3-**-	33	11.4	9.0	9.6	10.23	10.9
FH26W-35S-0.3SHW(**)	580-2410-2-**-	35	12.0	9.6	10.2	10.83	11.5
FH26W-37S-0.3SHW(**)	580-2411-5-**-	37	12.6	10.2	10.8	11.43	12.1
FH26W-39S-0.3SHW(**)	580-2412-8-**-	39	13.2	10.8	11.4	12.03	12.7
FH26W-41S-0.3SHW(**)	580-2413-0-**-	41	13.8	11.4	12.0	12.63	13.3
FH26W-45S-0.3SHW(**)	580-2414-3-**-	45	15.0	12.6	13.2	13.83	14.5
FH26W-51S-0.3SHW(**)	580-2415-6-**-	51	16.8	14.4	15.0	15.63	16.3
FH26W-57S-0.3SHW(**)	580-2417-1-**-	57	18.6	16.2	16.8	17.43	18.1
FH26W-61S-0.3SHW(**)	580-2418-4-**-	61	19.8	17.4	18.0	18.63	19.3
FH26W-71S-0.3SHW(**)	580-2419-7-**-	71	22.8	20.4	21.0	21.63	22.3

Note 1 : Embossed tape reel packaging(5,000pieces/reel, 500pieces/reel). Order by number of reels.

## Kameraanwendungen



Autopilot



Live-Streaming



Videokonferenz



Biometrische Eye-Tracker-Erkennung

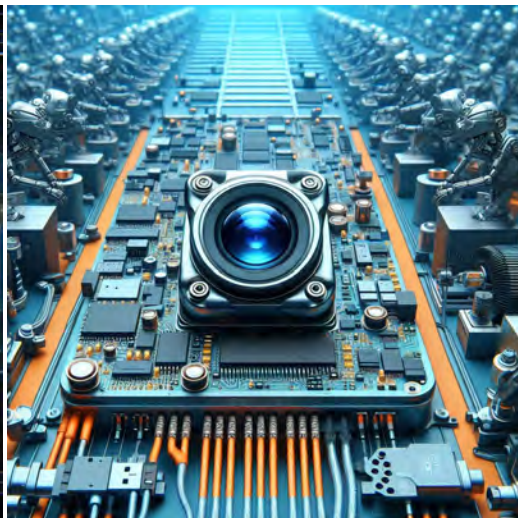

Maschinelles Sehen



Agrarmonitor



Nachtsichtsicherheit



Drohnen- und Sport-Adleraugen



Interaktive Haustierkamera

## Referenztable für die Pinbelegungsdefinition des Kameramoduls

OmniVision Sony Himax Samsung On-Semi Aptina Himax GalaxyCore PixArt Bildsensoren	
Pin Signal	Beschreibung
DGND GND	Masse für digitale Schaltung
AGND	Masse für analoge Schaltung
PCLK DCK	DVP-PCLK-Ausgang
XCLR PWDN XSHUTDOWN STANDBY	Abschalten aktiv hoch mit internem Pulldown-Widerstand
MCLK XVCLK XCLK INCK	Systemeingangsuhr
RESET RST	Aktiv Low mit internem Pull-up-Widerstand zurücksetzen
NC NULL	keine Verbindung
SDA SIO_D SIOD	SCCB-Daten
SCL SIO_C SOIC	SCCB-Eingangstakt
VSYNC XVS FSYNC	DVP-VSYNC-Ausgang
HREF XHS	DVP-HREF-Ausgang
DOVDD	Strom für E/A-Schaltung
AFVDD	Strom für VCM-Schaltung
AVDD	Strom für analoge Schaltung
DVDD	Strom für digitale Schaltung
STROBE FSTROBE	Strobe-Ausgang
FSIN	Synchronisieren Sie das VSYNC-Signal vom anderen Sensor
SID	SCCB letzte Bit-ID-Eingabe
ILPWM	mechanische Shutter-Ausgangsanzeige
FREX	Rahmenbelichtung / mechanischer Verschluss
GPIO	Allzweckeingänge
SLASEL	I2C-Slave-Adresse auswählen
AFEN	CEN-Chip aktivieren aktiv hoch auf VCM-Treiber-IC
<b>MIPI Schnittstelle</b>	
MDN0 DN0 MD0N DATA_N DMO1N	MIPI 1st negative Ausgabe der Datenspur
MDP0 DP0 MD0P DATA_P DMO1P	MIPI 1st positiver Ausgang der Datenspur
MDN1 DN1 MD1N DATA2_N DMO2N	MIPI 2nd negative Ausgabe der Datenspur
MDP1 DP1 MD1P DATA2_P DMO2P	MIPI 2nd positiver Ausgang der Datenspur
MDN2 DN2 MD2N DATA3_N DMO3N	MIPI 3rd negative Ausgabe der Datenspur
MDP2 DP2 MD2P DATA3_P DMO3P	MIPI 3rd positiver Ausgang der Datenspur
MDN3 DN3 MD3N DATA4_N DMO4N	MIPI 4th negative Ausgabe der Datenspur
MDP3 DP3 MD3P DATA4_P DMO4P	MIPI 4th positiver Ausgang der Datenspur
MCN CLKN CLK_N DCKN	MIPI Uhr negativer Ausgang
MCP CLKP MCP CLK_P DCKN	MIPI Takt positiver Ausgang
<b>DVP Parallel Schnittstelle</b>	
D0 DO0 Y0	DVP Datenausgabeport 0
D1 DO1 Y1	DVP Datenausgabeport 1
D2 DO2 Y2	DVP Datenausgabeport 2
D3 DO3 Y3	DVP Datenausgabeport 3
D4 DO4 Y4	DVP Datenausgabeport 4
D5 DO5 Y5	DVP Datenausgabeport 5
D6 DO6 Y6	DVP Datenausgabeport 6
D7 DO7 Y7	DVP Datenausgabeport 7
D8 DO8 Y8	DVP Datenausgabeport 8
D9 DO9 Y9	DVP Datenausgabeport 9
D10 DO10 Y10	DVP Datenausgabeport 10
D11 DO11 Y11	DVP Datenausgabeport 11

## Kamera-Zuverlässigkeitstest

Zuverlässigkeitsprüfpunkt		Testmethode	Akzeptanzkriterium	
Kategorie	Artikel			
Umwelt	Lager Temperatur	Hoch 60°C 96 Std	Temperaturkammer	Keine anormale Situation
		Niedrig -20°C 96 Std	Temperaturkammer	Keine anormale Situation
	Betriebs Temperatur	Hoch 60°C 24 Std	Temperaturkammer	Keine anormale Situation
		Niedrig -20°C 24 Std	Temperaturkammer	Keine anormale Situation
	Feuchtigkeit	60°C 80% 24 Std	Temperaturkammer	Keine anormale Situation
	Thermischer Schock	Hoch 60°C 0.5 Std Niedrig -20°C 0.5 Std Radfahren rein 24 Std	Temperaturkammer	Keine anormale Situation
Physisch	Falltest (Im freien Fall)	Ohne Verpackung 60cm	10 Mal auf Holzboden	Elektrisch funktionsfähig
		Mit Paket 60cm	10 Mal auf Holzboden	Elektrisch funktionsfähig
	Vibrations Test	50Hz X-Axis 2mm 30 Minuten	Vibrationstisch	Elektrisch funktionsfähig
		50Hz Y-Axis 2mm 30 Minuten	Vibrationstisch	Elektrisch funktionsfähig
		50Hz Z-Axis 2mm 30 Minuten	Vibrationstisch	Elektrisch funktionsfähig
	Zugfestigkeit des Kabels Krafttest	Gewicht laden 4 kg 60 Sekunden Radfahren rein 24 Std	Zugprüfmaschine	Elektrisch funktionsfähig
Elektrisch	ESD-Test	Kontaktaufnahme 2 KV	ESD-Prüfmaschine	Elektrisch funktionsfähig
		Luftentladung 4 KV	ESD-Prüfmaschine	Elektrisch funktionsfähig
	Alterungstest	On/Off 30 Sekunden Radfahren rein 24 Std	Stromschalter	Elektrisch funktionsfähig
	USB-Anschluss	On/Off 250 Mal	Einstecken und ausstecken	Elektrisch funktionsfähig



## Kamerainspektionsstandard

Inspektionsgegenstand		Untersuchungsmethode	Inspektionsstandard	
Kategorie	Artikel			
Aussehen	FPC oder PCB	Farbe	Das bloße Auge	Größere Unterschiede sind nicht zulässig.
		Zerrissen/gehackt werden	Das bloße Auge	Das Freilegen von Kupferrissen ist nicht zulässig.
		Markierung	Das bloße Auge	Klar, erkennbar (innerhalb von 30 cm Entfernung)
	Halterin	Kratzer	Das bloße Auge	Die Freilegung von Rissen im Inneren ist nicht zulässig
		Lücke	Das bloße Auge	Erfüllen Sie den Höhenstandard
		Schraube	Das bloße Auge	Stellen Sie sicher, dass Schrauben vorhanden sind (falls vorhanden)
		Schaden	Das bloße Auge	Die Freilegung von Rissen im Inneren ist nicht zulässig
	Linse	Kratzen	Das bloße Auge	Keine Auswirkung auf den Auflösungsstandard
		Kontamination	Das bloße Auge	Keine Auswirkung auf den Auflösungsstandard
		Ölfilm	Das bloße Auge	Keine Auswirkung auf den Auflösungsstandard
		Abdeckband	Das bloße Auge	Kein Problem beim Aussehen.
	Funktion	Bild	Keine Kommunikation	Testboard
Helles Pixel			Tafel	Im Image Center nicht erlaubt
Dunkles Pixel			Weißer Tafel	Im Image Center nicht erlaubt
Verschwommen			Das bloße Auge	Nicht erlaubt
Kein Bild			Das bloße Auge	Nicht erlaubt
Vertikale Linie			Das bloße Auge	Nicht erlaubt
Horizontale Linie			Das bloße Auge	Nicht erlaubt
Kleines Leck			Das bloße Auge	Nicht erlaubt
Blinkendes Bild			Das bloße Auge	Nicht erlaubt
Prellung			Inspektionslehre	Nicht erlaubt
Auflösung			Diagramm	Folgt dem Diagrammstandard für ausgehende Inspektionen
Farbe			Das bloße Auge	Kein Problem
Lärm			Das bloße Auge	Nicht erlaubt
Ecke dunkel			Das bloße Auge	Weniger als 100 x 100 Pixel
Farbauflösung			Das bloße Auge	Kein Problem
Abmessungen	Höhe	Das bloße Auge	Befolgt Zulassungsdatenblatt	
	Breite	Das bloße Auge	Befolgt Zulassungsdatenblatt	
	Länge	Das bloße Auge	Befolgt Zulassungsdatenblatt	
	Gesamt	Das bloße Auge	Befolgt Zulassungsdatenblatt	

## YDSCAM Paketlösungen

YDSCAM Kameramodul



Komplett mit Linsenschutzfolie



Tablett mit Gitter und Raum



Legen Sie die Kameras auf das Tablett





## YDSCAM Paketlösungen

Volles Fach mit Kameras



Decken Sie das Tablett mit dem Deckel ab

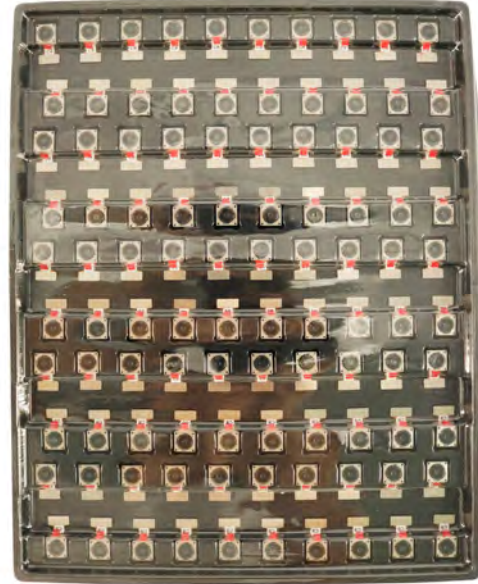

Legen Sie das Tablett in den antistatischen Beutel



Staubsaugen Sie den antistatischen Beutel



## YDSCAM Paketlösungen

Versiegelter antistatischer Vakuumbbeutel mit Etiketten

1. Modell und Beschreibung 2. Menge 3. Herstellungsdatumscode 4. Achtung



## YDSCAM Paketlösungen

Legen Sie Schaumstoffplatten zwischen die Tablettbeutel



Schaumstoffplatten sind größer als Tablettbeutels



Legen Sie Schaumstoffplatten und Tablettbeutels in den Karton



Die Schaumstoffplatten sitzen fest im Karton



Verschließen Sie die Carbon Box



Beschriften Sie den Carbon-Versandkarton



## YDSCAM Paketlösungen

USB-Kameramodul

Komplett mit Objektivschutzfolie

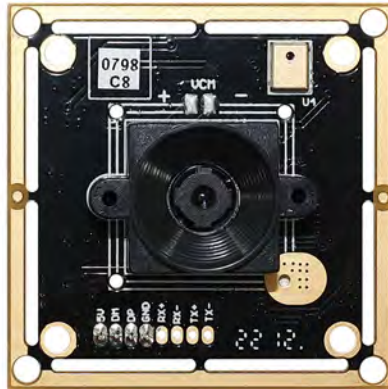

Legen Sie die Kameraprobe in den antistatischen Beutel

Legen Sie USB-Kameras in das Fach



Verschließen Sie das Tablett mit einem antistatischen Beutel

Beschriften Sie den Carbon-Versandkarton



## YDSCAM Paketlösungen

Legen Sie die Kameraprobe in den antistatischen Beutel



Legen Sie die Steckverbinder in den antistatischen Beutel



Beschriften Sie die Probenbeutel



Stecken Sie die Steckverbinder in die Spule



Legen Sie Proben in die Carbonbox



Stecken Sie die Steckverbinder in die Carbonbox





## Firma YDSCAM

YingDeShun Co. Ltd. (YDS) wurde 2017 gegründet, ein technologieorientierter Hersteller der nächsten Generation, der sich auf Forschung, Design und Produktion von Audio- und Videoprodukten spezialisiert hat. YDS verfügt über 20.000 Quadratmeter große automatisierte Anlagen mit 100 Mitarbeitern und einem Jahresdurchsatz von 30.000.000 Kameraeinheiten.

YDS bietet OEM- und ODM-Design sowie Auftragsfertigung und baut die Kameraprodukte. Sie können uns die Anforderungen mitteilen, sogar mit einem Handentwurf. Unser Vertrieb und unsere Technik arbeiten zusammen, um Ihre Anforderungen zu erfüllen. Wir verstehen uns als Ihr langfristiger Partner bei der Entwicklung praktischer und innovativer Lösungen.

Unser Team deckt alles von der ersten Konzeptentwicklung bis zum Massenprodukt ab. YDS ist auf kundenspezifisches Kameradesign, Rohmaterial, Elektroniktechnik, Firmware-/Softwareentwicklung, Produkttests und Verpackungsdesign spezialisiert. Unsere erfahrenen strategischen Liefersysteme bieten eine robuste und zuverlässige Fertigungskapazität für Aufträge unterschiedlicher Größe.

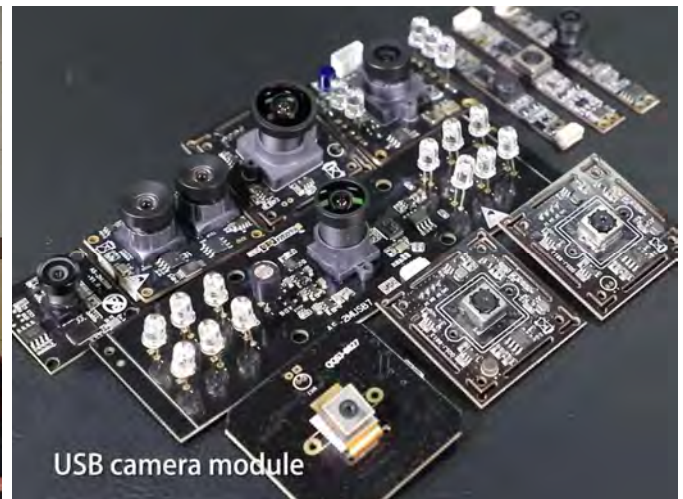

## Eingeschränkte Garantie

YDS gewährt die folgende eingeschränkte Garantie, wenn Sie das/die Produkt(e) direkt von der YDS-Firma oder über die YDS-Website [www.YDSCAM.com](http://www.YDSCAM.com) erworben haben. Von anderen Verkäufern oder Quellen gekaufte Produkte fallen nicht unter diese eingeschränkte Garantie. YDS garantiert, dass die Produkte bei normalem Gebrauch für einen Zeitraum von einem (1) Jahr ab dem Datum, an dem Sie das Produkt erhalten („Garanzzeitraum“), frei von Material- und Verarbeitungsfehlern sind.

Für alle Produkte, die während der Garanzzeit wesentliche Material- oder Verarbeitungsfehler aufweisen oder entwickeln, wird YDS nach eigenem Ermessen entweder: (i) das/die Produkt(e) reparieren; (ii) das/die Produkt(e) durch ein/e neue oder generalüberholte(n) Produkt(e) ersetzen (wobei das/die Ersatzprodukt(e) vom identischen Modell oder einer gleichwertigen Funktion sein müssen); oder (iii) Ihnen eine Rückerstattung des Preises gewähren, den Sie für das/die Produkt(e) bezahlt haben.

Diese eingeschränkte Garantie von YDS beschränkt sich ausschließlich auf Reparatur und/oder Ersatz gemäß den oben dargelegten Bedingungen. YDS ist nicht zuverlässig oder verantwortlich für etwaige Folgeereignisse.





# YDS CAMERA MODULE

*your best camera partner*

## Unsere Unternehmensstärke

Leistungsstarke Fabrik



Professioneller Service



Versprochene Lieferung



[www.YDSCAM.com](http://www.YDSCAM.com) [sales@ydscam.com](mailto:sales@ydscam.com) Phone (WeChat, QQ): (+86) 177 2732 6718

All rights reserved @ YingDeShun Co. Ltd. Specifications subject to change without notice.